



HOSHIZAKI

Product Catalogue - Version 4.0

Ice Machines, Dispensers & Crushers | Storage Bins & Transport Systems | Sushi Cases



HOSHIZAKI

C o n t e n t s



About Us	3
Built on Strong Foundations	5
Sustainable Innovation	6 - 7
Our Quality Marks	8 - 9
Ice Machines	11
Ice Types	13
Ice Sizes and Shapes	14 - 15
IM Product Highlights	17
Ice Production Process	18
IM-N Series, IM-N Hydrocarbon	19
IM Cube Ice Machines	20 - 24
IM Cylinder and Special Ice Machines	25 - 26
KM Product Highlights	27
KM Crescent Ice Machines	28 - 31
FM Product Highlights	33
FM Flake/Nugget/Cubelet Ice Machines	34 - 38
FM Hydrocarbon Machines	39 - 40
Ice and/or Water Dispensers	41
Product Highlights	43
Ice and/or Water Dispensers	44 - 45
Bins, Transport Systems, Crushers	47
Storage Bins	49 - 50
Top Kits	51
Transport Systems	52
Ice Bagging & Dispensing Systems	53
Ice Crushers	54
Sushi Cases	55
Product Highlights	57 - 59



About Us

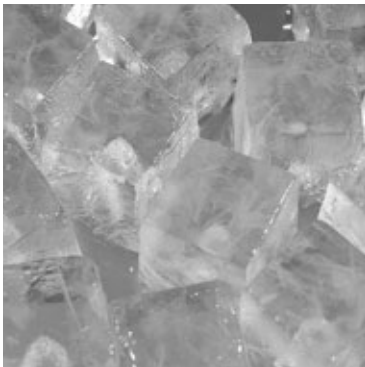





Built on Strong Foundations

Our Cool and Clean Mission

With over 60 years of experience in the commercial kitchen equipment and food service markets, Hoshizaki is a global market leader.

We designed and developed Japan's first fully automatic ice maker and from this pioneering base we have an ice making and refrigeration product range that exceeds expectations in the demanding sectors of food, beverage, bars and restaurants, bio-science, healthcare and education.

Hoshizaki has rightfully gained an international reputation for sustainable innovation, durability and reliability. All machines are designed and specified by Hoshizaki's dedicated Japanese Research and

Development team, which ensures Hoshizaki continues to devise innovative and sustainable products that cement the company's position as one of the world's visionary suppliers.

The company is noted for developing energy and water efficient, environmentally friendly (Hydro Fluorocarbon free) ice makers, adding value for the end-user through cost-saving and sustainability. Hoshizaki also innovates in the sectors it operates, for example in hospitality end-users can choose ice-makers that produce different types of ice from ball ice to flaked, which make the difference in quality beverages such as cocktails.

Find out more. Please visit www.hoshizaki-europe.com





Sustainable Innovation Hydrocarbon Technology

Hoshizaki has an understandable reputation for innovation, continually adding value for the end-user through cost-saving and sustainability.

Hoshizaki is proud to offer ice makers with HFC free refrigerant within the IM and FM Ranges.

The key point is that these ice makers are 'domestic' compliant, which is a significant step in sustainability. Smaller and medium sized operators can also benefit. In the past they were restricted to choosing larger commercial ice makers with a bigger environmental impact and larger price tag.

What are Hydrocarbons?

Hydrocarbons (HC's) are naturally occurring substances that have proven to be some of the most climate-friendly and cost-efficient refrigerants to heat, cool and freeze. Hydrocarbon refrigerants, hydrochlorofluoro-carbons (HCFC's) and hydrofluorocarbons (HFC's), are less damaging to the environment as they are non-toxic and non-ozone-depleting, making them a preferred choice for commercial cooling and freezing solutions.

The most commonly used HC refrigerants are propane and isobutane. Uses for propane include industrial freezers, refrigerators and ice makers whereas isobutane is utilised for domestic refrigerators and freezers. Hoshizaki, experts in commercial cooling and freezing equipment, have produced the world's first fully CE compliant R290 (propane) hydrocarbon ice makers. With the growing popularity for using hydrocarbons, Hoshizaki expects that the hydrocarbon refrigerant units will become an industry standard in the near future.



Benefits of Hydrocarbons

HC refrigerants have a multitude of benefits; perhaps the two most important attributes are that they do not contribute to the depletion of the ozone layer and that HC's maximize energy efficiency.

Most hydrocarbons used as refrigerants have a Global Warming Potential (GWP) of below 3, meaning they don't pose a threat to the earth's climate in small concentrations. By contrast, R404a, one of the chemical refrigerants hydrocarbons can replace, has a GWP of 3,260. To visualize this figure: 1 kg of released HFC- 404a heating up the atmosphere is equivalent to 1.1 tonnes of propane or isobutane!

Because of the reduced GWP, HC's also reduce the direct greenhouse gas (GHG) emissions. If a typical supermarket refrigeration system lost five to ten per cent of the total refrigerant charge to the atmosphere every year, and that continued, using hydrocarbons would spare

the planet tonnes of greenhouse gases compared to any other chemical refrigerant currently used.

HC's lower the indirect GHG emissions by maximising energy efficiency through a combination of factors, including their favourable thermodynamic characteristics, a higher Coefficient of Performance (COP), and a low condensing temperature.

Believing that hydrocarbons will play a major part within the future of refrigeration technology, Hoshizaki has committed to take a leading role in the design and manufacture of environmentally positive ice makers and refrigerators. Hoshizaki expert engineers are continuously striving to diversify and expand the hydrocarbon range to suit the needs of the global sectors using commercial cooling and freezing systems.



Our Quality Marks



- HACCP is a risk management tool recognized internationally for use in the proactive management of food and beverage safety issues.
- Hazard Analysis Critical Control Point (HACCP) is the main platform for International legislation and good manufacturing practices for all sectors of the food and beverage industry.
- HACCP also forms a key component of many certified compliance standards and is recognized as a main element of international trade in food and beverage products.
- The HACCP International Certification applies to the IM, FM/CM, KM and DCM series.



- ISO 9001 certification represents a formal acknowledgment by an accreditation organization that a company meets the intent of quality management standards issued by the International Organization for Standardization. A company receives this award after successfully passing an audit examining how well the standards were implemented and verifying the compliance of the company's employees to the guidelines. ISO 9001 aims at implementing processes that ensure customer satisfaction on a continuous basis.
- The ISO 9001 certification applies to both Hoshizaki's IM and FM series of ice makers.



- CE Marking on a product is a manufacturer's declaration that the product complies with the essential requirements of the relevant European health, safety and environmental protection legislation in place by many of the so-called Product Directives ('essential requirements' and/or 'performance levels' and 'Harmonized Standards' to which the products must conform).
- CE Marking on a product indicates to governmental officials that the product may be legally placed on the market in their country.
- CE Marking on a product ensures the free movement of the product within the EFTA & European Union (EU) single market (28 countries).
- CE Marking on a product permits the withdrawal of the non-conforming products by customs and enforcement/vigilance authorities.



- In the United Kingdom, Hoshizaki's IM, FM ice makers and DIM-30 Dispensers are in compliance with WRAS (Water Regulations Advisory Scheme).

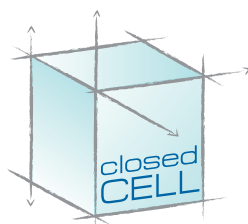

- Developed for the Hoshizaki IM-Range, the Closed Cell System causes the ice be more compact, hard and geometrically perfect.



- Developed for the KM Series.
- Hoshizaki Crescent ice makers (KM) produce the same quantity of ice in half as many cycles as competitor brands.
- Fewer cycles per day results in increased life & profits.
- It will take a Hoshizaki ice machine 15 years to accumulate as many cycles as the competition in 6 years.
- Reduced energy consumption, cleaning and maintenance.



- The system EverCheck gives a visible and audible alarm when the machine needs maintenance assistance.
- Beneficial to alert the operator immediately, in case a problem occurs.
- Reduces down-time and, as a consequence, the possible financial impact.
- Specifically developed for the KM Series.



- This system has been invented for Hoshizaki.
- It extracts impurities and minerals from the water, which makes the ice production cleaner.
- Reduced cleaning and maintenance of machine.
- Developed for the FM Series.



- With a clear focus on sustainable innovation, Hoshizaki has significantly improved the performance of the IM Range in terms of water consumption. All N Series products within the IM Range are labelled with the Eco – Friendly mark.



- All HFC Ice makers within the IM and FM Ranges are labelled with this mark. Our development team is continuously striving to diversify and expand the hydrocarbon range to meet industry needs.





Ice Machines







An Ice For All Reasons

Hoshizaki's wide range of ice makers caters for a host of requirements and we have developed innovative solutions that are tailored to the demands of a wide range of locations and operations.

We provide industry-specific solutions for the needs of the restaurant, bar, fresh produce, food processing, bakery, education, healthcare catering and clinical markets so operators can deliver the best possible service to their customers or clients.



We call upon our vast technical know-how and end-user knowledge to design and develop ice makers for the production of cube ice, crescent ice, flake ice, nugget ice, in addition to ice dispensers. You will see Hoshizaki ice making equipment and ice dispensing systems in

front-of-house and back-of house locations at the world's leading bar and restaurant brands, and you are just as likely to find them performing critical functions on a deep sea fishing vessel.

Our hi-tech, efficient machines are renowned for their outstanding performance and durability to withstand the toughest commercial pressures. The basic designs and major component parts are specified for a global market meaning that Hoshizaki machines will effortlessly and quickly achieve outstanding levels of efficiency in ambient temperatures of between 5°C and 40°C, even in humid environments.

Ice Types

Regular Ice Types

					
Cube Ice	Cylinder Ice	Crescent Ice	Flake(F) / Nugget(N) Ice	Cubelet	Shuttle Ice
Product Series					
IM, DIM	IM-C*	KM	FM	DCM, CM	DSM

Special Ice Types

				
Ball Ice 45mm / 45g	Star Shaped	Heart Shaped	Big Cube 48 x 48 x 58 mm	Long Cube 103 x 48 x 58mm
Product Series				
IM-65NE-Q*	IM-65NE-S*	IM-65NE-H*	IM-65NE-LM*	IM-65NE-LM103*

* These are special types of ice and the machines can only be ordered on special request. Therefore take into account a longer delivery time.



Ice Sizes & Shapes (approx)

Hoshizaki ice machines produce exceptionally hard, pure ice cubes.

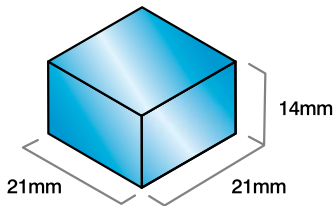

Small (S) (21)*

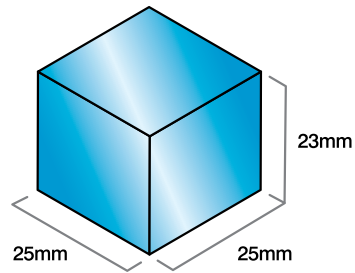

Medium (M) (25)*

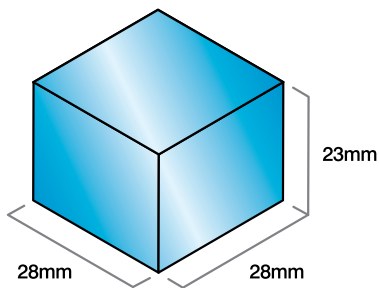

Medium/Large (M/L) (23)*

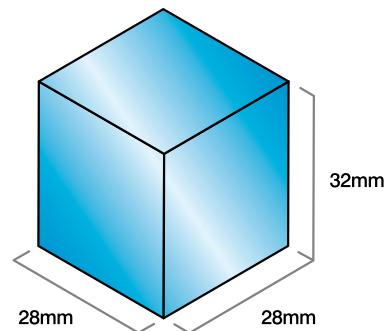

Large Standard (L)(28)*

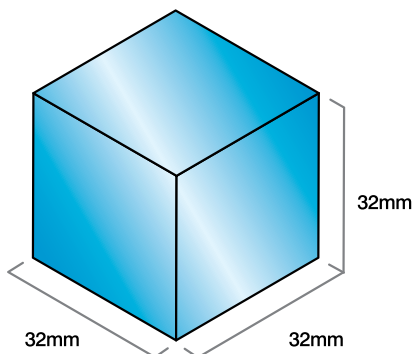

Extra Large (XL)(32)*

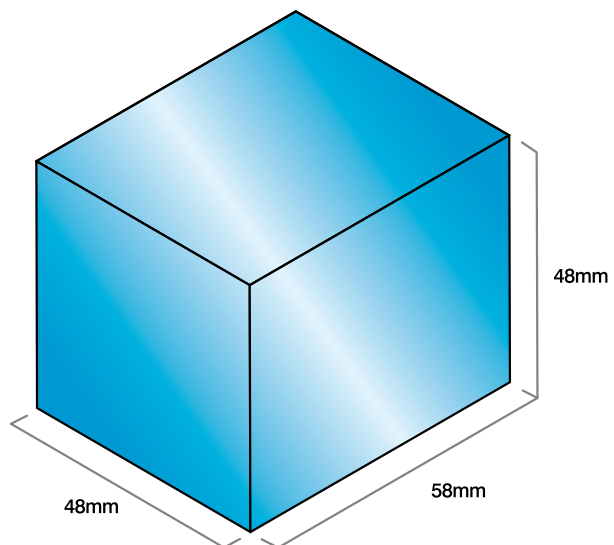

Big Cube (LM)*

*Size of Ice Cube mentioned in brackets () is reflected in product names of the IM Series.
E.g. (21) in IM-CNE-21 refers to a Cube Size Small

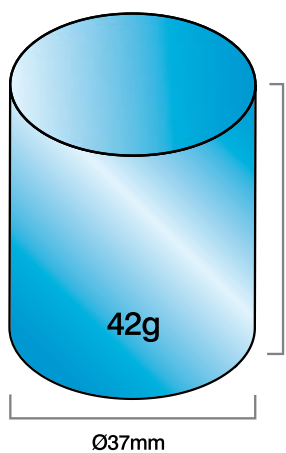

Cylinder

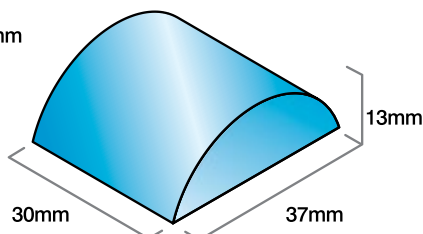

Crescent

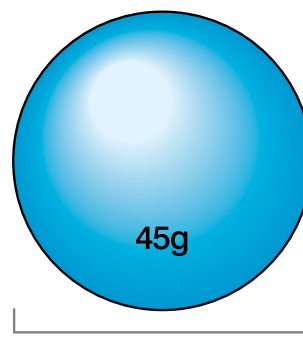

Ball

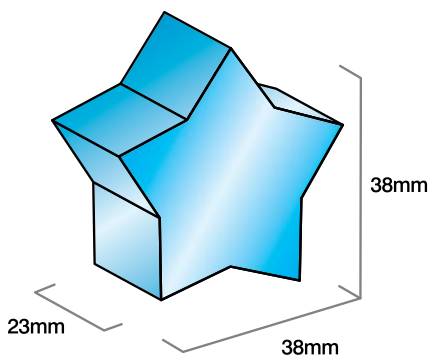

Star

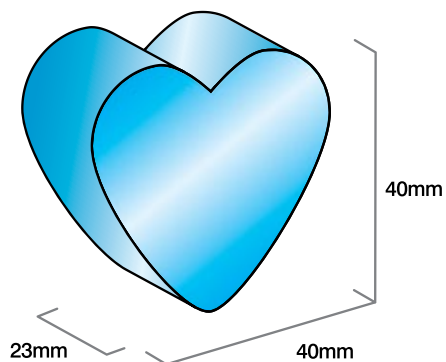

Heart

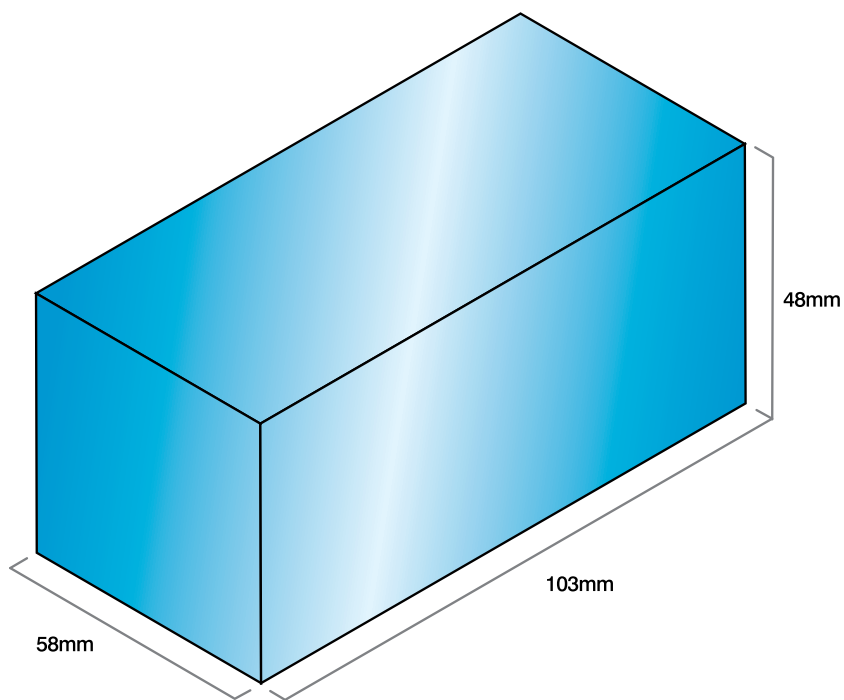

Long Cube (LM-103)



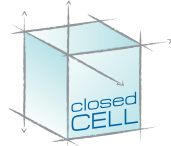

IM Product Highlights

The unique IM Range of Ice Machines is designed with hygiene as a priority. Each ice cycle is made with fresh water, ensuring only the highest quality of ice is produced. This is particularly important for ice to be used in premium beverages like cocktails, as it protects the integrity and flavour of the drink.



Hoshizaki IM Machines utilise a closed cell ice making system that has an automatic flush cycle. After every new batch of ice, the water reservoir will drain and refill with fresh water.



A stainless steel exterior with integrated door handles provides a hygienic and high quality finish.



Removable door gaskets prevent any heat and contamination from entering the bin and make the Hoshizaki product easy to clean and maintain.



A closed water circuit offers the ultimate contamination protection, by reducing the number of points at which impurities can enter the ice making process.



An easily cleanable air filter allows users to carry out a routine cleaning schedule themselves, extending the life expectancy of your Hoshizaki ice maker, and cutting the frequency and cost of maintenance call-outs.



Ice machines are computer controlled so the ice making process is optimised under varying circumstances without the need for physical adjustments.

Foam injected polyurethane for outstanding insulation (HFC free) preserves the quality and consistency of the ice produced longer than any other machine available. This reduces the number of production cycles, saving energy and money.





Ice Production Process

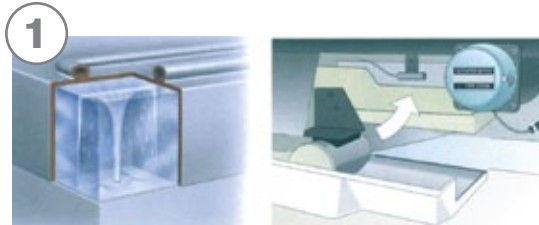
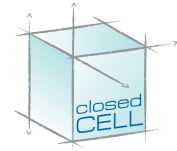

1
With the water plate closed against the underside of the evaporator, the water circuit is closed to both outside contamination and water loss under normal circumstances. Crucially, each cube is made individually by a dedicated jet spray to ensure the highest possible ice quality.

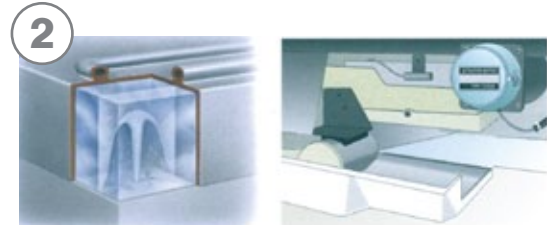

2
As the ice cube slowly forms the spray continues until the end of the cycle. No fresh water is required as the internal reservoir capacity is adequate for a full cycle of ice.

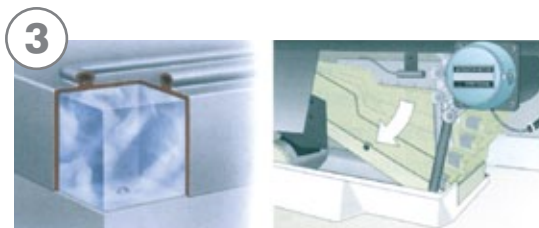

3
When the cube is fully formed the electronic controller initiates a hot gas defrost cycle. The water plate opens and the hot gas slowly warms the evaporator. At this point all remaining water from the ice making cycle is drained.

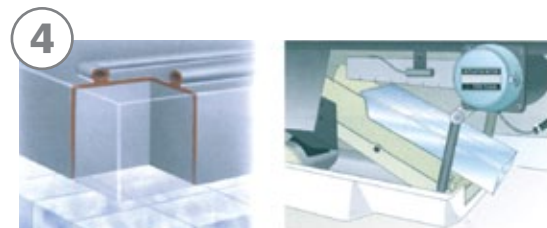

4
The ice will drop from the evaporator into the ice bin. The water plate will be rinsed with fresh water to remove any remaining particles before it starts to close again. Fresh water continues to enter until the reservoir is full to enable a new freeze cycle to commence.



The IM-N Series ECOFRIENDLY

The recently launched IM-N Series is a new range of ice makers true to Hoshizaki’s reputation for durability and efficiency. Hoshizaki delivers cutting edge innovation to support sustainability.

With a brief to extend our commitment to developing more efficient ice makers, Hoshizaki has significantly improved the performance of the IM range in the increasingly important area of water consumption.

With notable improvements in sustainability design, customers can save money and improve their overall performance.



Model Name Changes:

L/M Series	New N Series
IM-21CLE	IM-21CNE
IM-30CLE	IM-30CNE
IM-45LE	IM-45NE
IM-45CLE	IM-45CNE
IM-65LE	IM-65NE
IM-100LE	IM-100NE
IM-130ME	IM-130NE
IM-240M2E	IM-240NE
IM-240DME	IM-240DNE
IM-240AME	IM-240ANE



Notable Improvements Include:

- The development of a new intelligent control circuit dedicated to reducing water consumption
- Modern design with easy – to use control panel



IM-N HydroCarbon Ice Machines Now Available

Hoshizaki extends its IM-N range with the IM240ANE-HC.

- The IM-240ANE-HC can produce up to approx. 230 kilos of cube ice in just 24 hours and still use just 50 per cent of the legal allowance of hydrocarbon.
- Utilises only 0.870kW per hour, which is 34 per cent less energy consumption than Hoshizaki’s conventional IM-240ANE model and an over 99 per cent cut in global warming potential, compared to the same IM model.
- The HC ice maker reduces energy bills, adding to their sustainability credentials.



IM Ice Machines - Self Contained

www.hoshizaki-europe.com



IM-21CNE

Production Capacity (kg/24h) Approx.	22
Storage Bin Capacity (kg) Approx.	11,5
Dimensions W x D x H (mm)	398 x 446 x 695
Electrical Supply	1/220 - 240V/50Hz
Electrical Capacity (kW)	0,24
Refrigerant	R134a
Weight Gross / Net (kg)	38/34
Air Cooled Model(s)	IM-21CNE
Type of Ice	IM-21CNE – Large Cube
Optional	Legs for IM-21CNE



IM-30CNE

Production Capacity (kg/24h) Approx.	28
Storage Bin Capacity (kg) Approx.	11,5
Dimensions W x D x H (mm)	398 x 446 x 695 (Legs Add 100-135mm)
Electrical Supply	1/220 - 240V/50Hz
Electrical Capacity (kW)	0,27
Refrigerant	R134a
Weight Gross / Net (kg)	38/34
Air Cooled Model(s)	IM-30CNE, IM-30CNE-25
Water Cooled Model(s)	IM-30CWNE
Type of Ice	IM-30CNE, IM-30CWNE – Large Cube IM-30CNE-25 – Medium Cube



IM-45CNE

Production Capacity (kg/24h) Approx.	44
Storage Bin Capacity (kg) Approx.	15
Dimensions W x D x H (mm)	633 x 506 x 690 (Legs Add 100-135mm)
Electrical Supply	1/220 - 240V/50Hz
Electrical Capacity (kW)	0,32
Refrigerant	R134a
Weight Gross / Net (kg)	55/48
Air Cooled Model(s)	IM-45CNE, IM-45CNE-25
Type of Ice	IM-45CNE – Large Cube IM-45CNE-25 – Medium Cube

*These products can be produced upon customer request. Please take longer lead times into consideration.

• Data shows the standard air cooled model • Production capacity (kg/24h): AT10°C, WT10°C



IM-45NE

Production Capacity (kg/24h) Approx.	44
Storage Bin Capacity (kg) Approx.	18
Dimensions W x D x H (mm)	503 x 456 x 840 (Legs Add 100-135mm)
Electrical Supply	1/220 - 240V/50Hz
Electrical Capacity (kW)	0,33
Refrigerant	R134a
Weight Gross / Net (kg)	51/46
Air Cooled Model(s)	IM-45NE, IM-45NE-25
Water Cooled Model(s)	IM-45WNE
Type of Ice	IM-45NE, IM-45WNE – Large Cube IM-45NE-25 – Medium Cube



IM-65NE

Production Capacity (kg/24h) Approx.	63
Storage Bin Capacity (kg) Approx.	26
Dimensions W x D x H (mm)	633 x 506 x 840 (Legs Add 100-135mm)
Electrical Supply	1/220 - 240V/50Hz
Electrical Capacity (kW)	0,40
Refrigerant	R134a
Weight Gross / Net (kg)	60/53
Air Cooled Model(s)	IM-65NE, IM-65NE-25
Water Cooled Model(s)	IM-65WNE
Type of Ice	IM-65NE, IM-65WNE – Large Cube IM-65NE-25 – Medium Cube



IM-100CNE

Production Capacity (kg/24h) Approx.	95
Storage Bin Capacity (kg) Approx.	38
Dimensions W x D x H (mm)	1004 x 600 x 800 (Legs Add 90-130mm)
Electrical Supply	1/220 - 240V/50Hz
Electrical Capacity (kW)	0,63
Refrigerant	R134a
Weight Gross / Net (kg)	90/77
Air Cooled Model(s)	IM-100CNE, IM-100CNE-23, IM-100CNE-21*
Type of Ice	IM-100CNE – Large Cube IM-100CNE-23 – Medium / Large Cube IM-100CNE-21* – Small Cube



*These products can be produced upon customer request. Please take longer lead times into consideration.

• Data shows the standard air cooled model • Production capacity (kg/24h): AT10°C, WT10°C



IM Ice Machines - Self Contained

www.hoshizaki-europe.com



IM-100NE

Production Capacity (kg/24h) Approx.	95
Storage Bin Capacity (kg) Approx.	50
Dimensions W x D x H (mm)	704 x 506 x 1200 (Legs Add 90-130mm)
Electrical Supply	1/220 - 240V/50Hz
Electrical Capacity (kW)	0,63
Refrigerant	R134a
Weight Gross / Net (kg)	84/76
Air Cooled Model(s)	IM-100NE, IM-100NE-23, IM-100NE-21*
Water Cooled Model(s)	IM-100WNE, IM-100WNE-23, IM-100WNE-21*
Type of Ice	IM-100NE, IM-100WNE – Large Cube IM-100NE-23, IM-100WNE-23 – Medium / Large Cube IM-100NE-21*, IM-100WNE-21* – Small Cube



IM-130NE

Production Capacity (kg/24h) Approx.	130
Storage Bin Capacity (kg) Approx.	50
Dimensions W x D x H (mm)	704 x 506 x 1200 (Legs Add 90-130mm)
Electrical Supply	1/220 - 240V/50Hz
Electrical Capacity (kW)	0,70
Refrigerant	R404A
Weight Gross / Net (kg)	84/76
Air Cooled Model(s)	IM-130NE, IM-130NE-23, IM-130NE-21*
Water Cooled Model(s)	IM-130WNE
Type of Ice	IM-130NE, IM-130WNE – Large Cube IM-130NE-23 – Medium / Large Cube IM-130NE-21* – Small Cube



IM-240NE

Production Capacity (kg/24h) Approx.	240
Storage Bin Capacity (kg) Approx.	110
Dimensions W x D x H (mm)	704 x 665 x 1510 (Legs Add 90-130mm)
Electrical Supply	1/220 - 240V/50Hz
Electrical Capacity (kW)	1,32
Refrigerant	R404A
Weight Gross / Net (kg)	122/111
Air Cooled Model(s)	IM-240NE, IM-240NE-23, IM-240NE-21*
Water Cooled Model(s)	IM-240WNE
Type of Ice	IM-240NE, IM-240WNE – Large Cube IM-240NE-23 – Medium / Large Cube IM-240NE-21* – Small Cube

*These products can be produced upon customer request. Please take longer lead times into consideration.

• Data shows the standard air cooled model • Production capacity (kg/24h): AT10°C, WT10°C



IM-240ANE

Production Capacity (kg/24h) Approx.	240
Dimensions W x D x H (mm) Approx.	560 x 700 x 880
Electrical Supply	1/220 - 240V/50Hz
Electrical Capacity (kW)	1,32
Refrigerant	R404A
Weight Gross / Net (kg)	91/80
Corresponding Bins	B-301SA, B-501SA, B-801SA
Top Kits	See page 51 for Configurations
Air Cooled Model(s)	IM-240ANE, IM-240ANE-23, IM-21ANE-21*
Water Cooled Model(s)	IM-240AWNE
Type of Ice	IM-240ANE, IM-240AWNE – Large Cube IM-240AWNE-23 – Medium / Large Cube IM-240ANE-21* – Small Cube

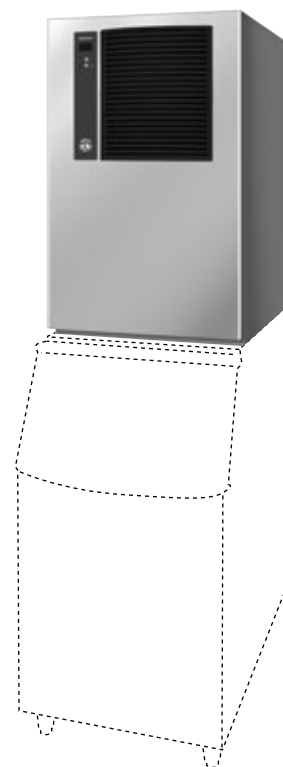

IM-240ANE-HC

Production Capacity (kg/24h) Approx.	235
Dimensions W x D x H (mm) Approx.	560 x 700 x 880
Electrical Supply	1/220 - 240V/50Hz
Electrical Capacity (kW)	0.93
Refrigerant	R290
Weight Gross / Net (kg)	89/78
Corresponding Bins	B-301SA, B-501SA, B-801SA
Top Kits	See page 51 for Configurations
Air Cooled Model(s)	IM-240ANE-HC, IM-240ANE-HC-23
Type of Ice	IM-240ANE-HC – Large Cube IM-240ANE-HC-23 – Medium / Large Cube

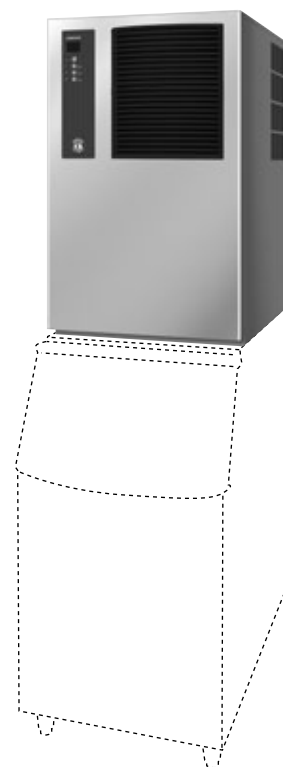

*These products can be produced upon customer request. Please take longer lead times into consideration.

• Data shows the standard air cooled model • Production capacity (kg/24h): AT10°C, WT10°C

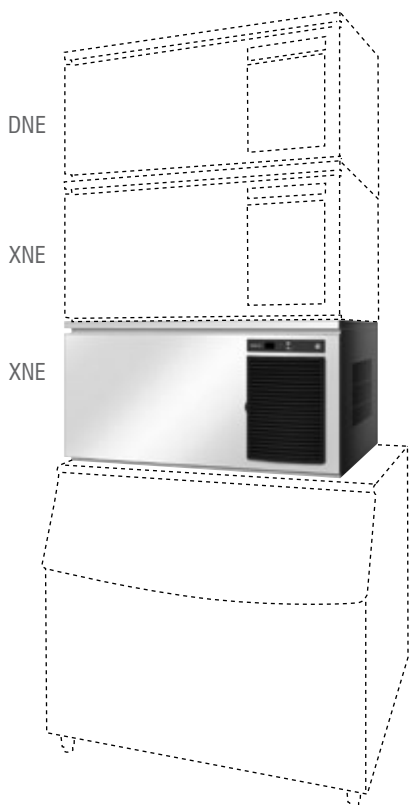

IM-240D(W)NE / IM-240X(W)NE / IM-240DSNE* / IM-240XSNE*

Production Capacity (kg/24h) Approx.	240/480/720**
Dimensions W x D x H (mm)	1084 x 700 x 500
Electrical Supply	1/220 - 240V/50Hz
Electrical Capacity (kW)	1,33
Refrigerant	R404A
Weight Gross / Net (kg)	106/88
Corresponding Bins	B-801SA, F650, 950/1025
Top Kits	See page 51 for Configurations
Air Cooled Model(s)	IM-240DNE IM-240DNE-23 IM-240DNE-21* IM-240DNE-32* IM-240XNE IM-240XNE-23 IM-240XNE-21* IM-240XNE-32*
Water Cooled Model(s)	IM-240DWNE IM-240DWNE-23* IM-240DWNE-21* IM-240DWNE-32* IM-240XWNE IM-240XWNE-23* IM-240XWNE-21* IM-240XWNE-32*
Air Cooled Model(s) With External Condenser	IM-240DSNE* IM-240DSNE-23* IM-240XSNE* IM-240XSNE-23*
Type of Ice	IM-240DNE, IM-240XNE, IM-240DWNE, IM-240XWNE, IM-240DSNE*, IM-240XSNE* – Large Cube IM-240DNE-23, IM-240XNE-23, IM-240DWNE-23*, IM-240XWNE-23* IM-240DSNE-23*, IM-240XSNE-23* – Medium / Large Cube IM-240DNE-21*, IM-240XNE-21*, IM-240DWNE-21*, IM-240XWNE-21* – Small Cube IM-240DNE-32*, IM-240XNE-32* IM-240DWNE-32*, IM-240XWNE-32* – Extra Large Cube
Remote Condenser	URC-240CE
Extension Machines	IM-240XNE, IM-240XNE-23, IM-240XNE-21*, IM-240XNE-32*, IM-240XWNE, IM-240XWNE-23*, IM-240XWNE-21*, IM-240XWNE-32*, IM-240XSNE*, IM-240XSNE-23*

*These products can be produced upon customer request. Please take longer lead times into consideration.

**IM-240XNE extension machine for 480 kg (DNE+XNE) or 720 kg (DNE+2x XNE).

It is possible to stack the IM-240DNE on top of two IM-240XNE for a higher production capacity.

• Data shows the IM-240DNE • Production capacity (kg/24h): AT10°C, WT10°C



IM-65LE-C*

Production Capacity (kg/24h) Approx.	55
Storage Bin Capacity (kg) Approx.	26
Dimensions W x D x H (mm)	633 x 506 x 850 (Legs Add 100-135mm)
Electrical Supply	1/220 - 240V/50Hz
Electrical Capacity (kW)	0,43
Refrigerant	R134a
Weight Gross / Net (kg)	69/63
Air Cooled Model(s)	IM-65LE-C*
Type of Ice	Cylinder Ice



IM-100LE-C*

Production Capacity (kg/24h) Approx.	85
Storage Bin Capacity (kg) Approx.	50
Dimensions W x D x H (mm)	704 x 506 x 1200 (Legs Add 90-130mm)
Electrical Supply	1/220 - 240V/50Hz
Electrical Capacity (kW)	0,65
Refrigerant	R134a
Weight Gross / Net (kg)	90/80
Air Cooled Model(s)	IM-100LE-C*
Type of Ice	Cylinder Ice



IM-130ME-C*

Production Capacity (kg/24h) Approx.	105
Storage Bin Capacity (kg) Approx.	50
Dimensions W x D x H (mm)	704 x 506 x 1200 (Legs Add 90-130mm)
Electrical Supply	1/220 - 240V/50Hz
Electrical Capacity (kW)	0,71
Refrigerant	R404A
Weight Gross / Net (kg)	90/80
Air Cooled Model(s)	IM-130ME-C*
Type of Ice	Cylinder Ice



*These products can be produced upon customer request. Please take longer lead times into consideration.

- Production capacity (kg/24h): AT10°C, WT10°C

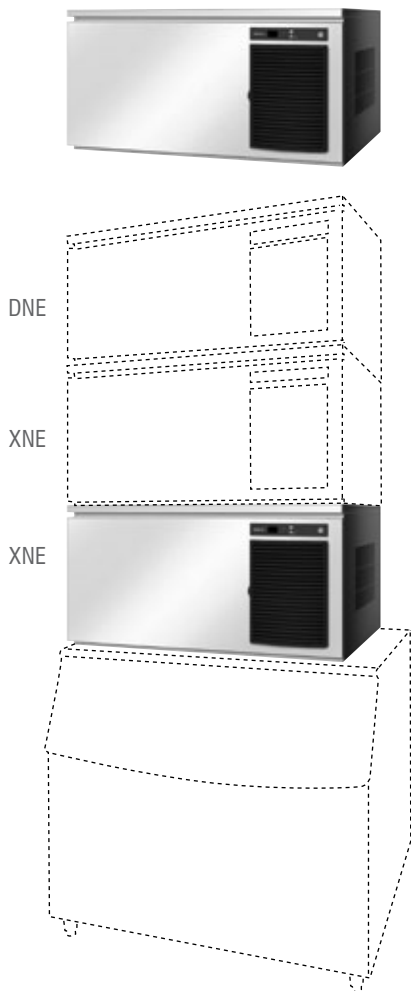

IM-240D(W)NE*/X(W)NE-C*

Production Capacity (kg/24h) Approx.	240/480/720**
Dimensions W x D x H (mm)	1084 x 700 x 500
Electrical Supply	1/220 - 240V/50Hz
Electrical Capacity (kW)	1,33
Refrigerant	R404A
Weight Gross / Net (kg)	102/89
Corresponding Bins	B-801SA, F650, 950/1025
Top Kits	See page 51 for Configurations
Air Cooled Model(s)	IM-240DNE-C*, IM-240XNE-C*
Water Cooled Model(s)	IM-240DWNE-C*, IM-240XWNE-C*
Type of Ice	Cylinder Ice
Extension Machines	IM-240XNE-C, IM-240XWNE-C

**IM-240XNE-C extension machine for 480 kg (DNE+XNE) or 720 kg (DNE+2x XNE). It is possible to stack the IM-240DNE-C on top of two IM-240XNE-C for a higher production capacity.

- Data shows the IM-240DNE-C



• Photo of IM-65NE-H/S

IM-65NE-Q*/H*/S*/LM*/LM103*

Production Capacity (kg/24h) Approx.	26(Q) / 28(H) / 22(S) / 40(LM) /32(LM103)
Storage Bin Capacity (kg) Approx.	17(Q) / 26(H,S,LM,LM103)
Dimensions W x D x H (mm)	633 x 506 x 860 (Q,LM,LM103) 633 X 506 X 840 (H,S) (Legs Add 90-135mm)
Electrical Supply	1/220 - 240V/50Hz
Electrical Capacity (kW)	0,39 (Q), 0,40 (H,S,LM,LM103)
Refrigerant	R134a
Weight Gross / Net (kg)	61/53
Air Cooled Model(s)	IM-65NE-Q*/H*/S*/LM*/LM103*
Type of Ice	Ball Ice (Q), Heart Ice (H), Star Ice (S) Big Ice (LM), Long Ice (LM103)

*These products can be produced upon customer request. Please take longer lead times into consideration.

- Production capacity (kg/24h): AT10°C, WT10°C



KM Product Highlights



KM machines produce clear, crescent shaped ice. The unique shape is extremely versatile and extends from the splash-free serving of post mix soft drinks through to diverse applications such as fish transportation, display and even laser therapy.



This range includes a double-sided stainless steel evaporator, which requires fewer cycles to produce a full bin of ice, thereby reducing energy consumption.



All units are easily accessible for service via the front of unit. This reduces the time it takes to complete maintenance tasks



Ice machines are computer controlled so the ice making process is optimised under varying circumstances without the need for physical adjustments.



An easily cleanable air filter allows users to carry out a routine cleaning schedule themselves, extending the life expectancy of the ice maker, and cutting the frequency and cost of maintenance call-outs.





KM Ice Machines - Self Contained

www.hoshizaki-europe.com



KM-35A

Production Capacity (kg/24h) Approx.	36
Storage Bin Capacity (kg) Approx.	16
Dimensions W x D x H (mm)	450 x 610 x 842
Electrical Supply	1/220 - 240V/50Hz
Electrical Capacity (kW)	0,195
Refrigerant	R134a
Weight Gross / Net (kg)	49/39
Air Cooled Model(s)	KM-35A
Type of Ice	Crescent
Optional	Set of 4 legs. Adds 90 - 135mm to height



KM-50A

Production Capacity (kg/24h) Approx.	52
Storage Bin Capacity (kg) Approx.	23
Dimensions W x D x H (mm)	603 x 610 x 842
Electrical Supply	1/220 - 240V/50Hz
Electrical Capacity (kW)	0,303
Refrigerant	R134a
Weight Gross / Net (kg)	58/46
Air Cooled Model(s)	KM-50A
Type of Ice	Crescent
Optional	Set of 4 legs. Adds 90 - 135mm to height



KM-75A

Production Capacity (kg/24h) Approx.	72
Storage Bin Capacity (kg) Approx.	40
Dimensions W x D x H (mm)	603 x 712 x 842
Electrical Supply	1/220 - 240V/50Hz
Electrical Capacity (kW)	0,412
Refrigerant	R134a
Weight Gross / Net (kg)	64/51
Air Cooled Model(s)	KM-75A
Type of Ice	Crescent
Optional	Set of 4 legs. Adds 90 - 135mm to height

- Production capacity (kg/24h): AT10°C, WT10°C



KM-100A

Production Capacity (kg/24h) Approx.	101
Storage Bin Capacity (kg) Approx.	45
Dimensions W x D x H (mm)	612 x 712 x 992
Electrical Supply	1/220 - 240V/50Hz
Electrical Capacity (kW)	0,584
Refrigerant	R404A
Weight Gross / Net (kg)	82/62
Air Cooled Model(s)	KM-100A
Type of Ice	Crescent



KM-125A

Production Capacity (kg/24h) Approx.	128
Storage Bin Capacity (kg) Approx.	55
Dimensions W x D x H (mm)	762 x 712 x 992
Electrical Supply	1/220 - 240V/50Hz
Electrical Capacity (kW)	0,774
Refrigerant	R404A
Weight Gross / Net (kg)	92/70
Air Cooled Model(s)	KM-125A
Type of Ice	Crescent



KM-320MAH-E / KM-515MAH-E

Production Capacity (kg/24h) Approx.	157 / 264
Dimensions W x D x H (mm)	560 x 695 x 770
Electrical Supply	1/220 - 240V/50Hz
Electrical Capacity (kW)	0,71 / 1,2
Refrigerant	R404A
Weight Gross / Net (kg)	79/69, 79/68
Air Cooled Model(s)	KM-320MAH-E, KM-515MAH-E
Type of Ice	Crescent
Corresponding Bins	B-301SA, B-501SA, B-801SA

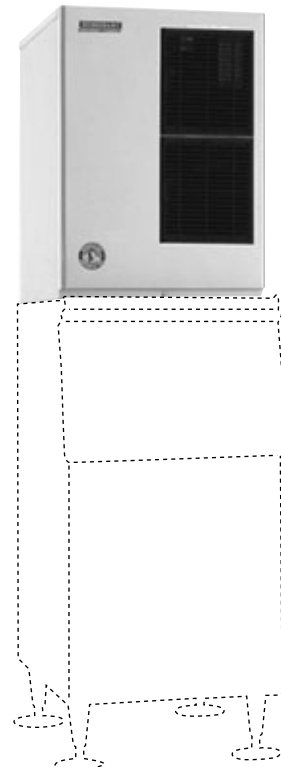

• Production capacity (kg/24h): AT10°C, WT10°C

• Photo of KM-515MAH-E



KM Ice Machines - Modular

www.hoshizaki-europe.com

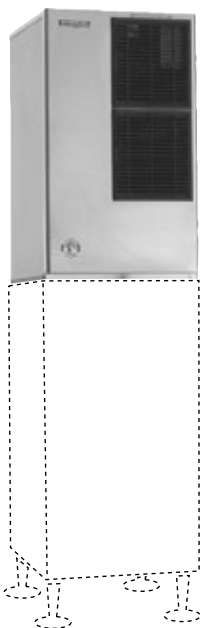

KM-650MAH-E

Production Capacity (kg/24h) Approx.	333
Dimensions W x D x H (mm)	560 x 695 x 950
Electrical Supply	1/220 - 240V/50Hz
Electrical Capacity (kW)	1,2
Refrigerant	R404A
Weight Gross / Net (kg)	91/77
Air Cooled Model(s)	KM-650MAH-E
Type of Ice	Crescent
Corresponding Bins	B-301SA, B-501SA, B-801SA

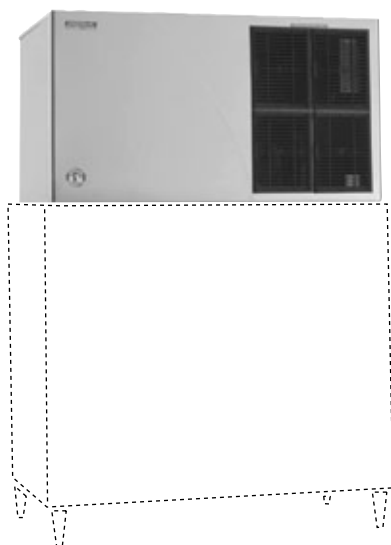

KM-1301SAH-E

Production Capacity (kg/24h) Approx.	584
Dimensions W x D x H (mm)	1219 x 695 x 695
Electrical Supply	1/220 - 240V/50Hz
Electrical Capacity (kW)	2,12
Refrigerant	R404A
Weight Gross / Net (kg)	143/125
Corresponding Bins	B-801SA
Air cooled model(s)	KM-1301SAH-E
Water Cooled Model(s)	KM-1301SWH-E*
Type of Ice	Crescent
Remote Condenser Unit	KM-1301SRH-E*
Remote Condenser	URC14FE
Remote Condenser Connection Set	OS Quick

KM-1301 can be stacked 2 high for 1168kg production

• Data shows the standard air cooled model • Production capacity (kg/24h): AT10°C, WT10°C



KMD-201AA

Production Capacity (kg/24h) Approx.	190
Dimensions W x D x H (mm)	560 x 625 x 610
Electrical Supply	1/220 - 240V/50Hz
Electrical Capacity (kW)	0,7
Refrigerant	R404A
Weight Gross / Net (kg)	73/57
Corresponding Bins	B-301SA, B-501SA, B-801SA and Lancer dispensers
Air cooled Model(s)	KMD-201AA
Water Cooled Model(s)	KMD-201AWA
Type of Ice	Crescent

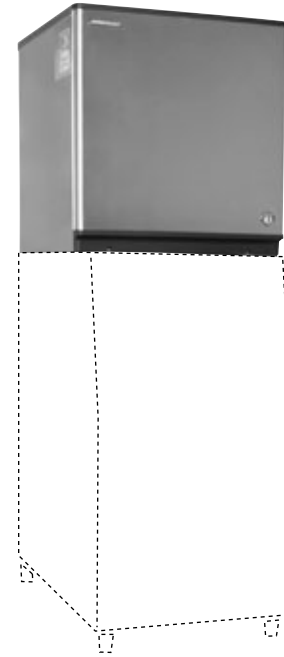

KMD-201AA on top of Lancer dispenser IBD4400



KMD-270AA

Production Capacity (kg/24h) Approx.	265
Dimensions W x D x H (mm)	560 x 625 x 610
Electrical Supply	1/220 - 240V/50Hz
Electrical Capacity (kW)	1,03
Refrigerant	R404A
Weight Gross / Net (kg)	73/57
Corresponding Bins	B-301SA, B-501SA, B-801SA and Lancer dispensers
Air cooled Model(s)	KMD-270AA
Water Cooled Model(s)	KMD-270AWA
Type of Ice	Crescent

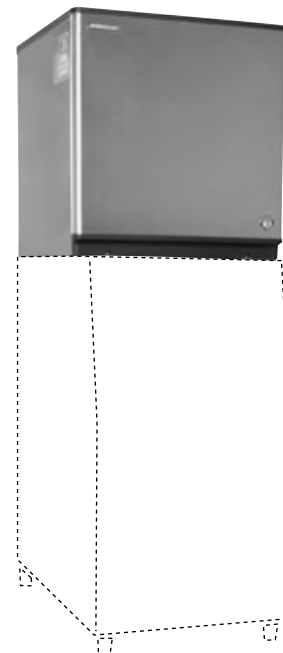

• Data shows the standard air cooled model • Production capacity (kg/24h): AT10°C, WT10°C





FM Product Highlights

The FM series produce flake/nugget ice, with the nugget ice compressed during production to make it long-lasting. The flake and nugget ice is popular for a variety of cooling purposes including the display of fish and fresh produce, and also in the medical world for cooling blood and organs.



The characteristics of the ice produced by Hoshizaki ice makers means that 'freeze-burn' is no longer an issue when displaying fresh fish or produce.



Carbon auger bearings are used within this range and they are far more robust than roller bearings, enhancing product life expectancy and also reducing maintenance costs.



Flake



Nugget



Cubelet Ice

Hoshizaki ice machines in this range can be converted to either flake or nugget ice relatively inexpensively, providing a higher level of flexibility than other machines on the market.

	Ice	Water
Flake Ice	70%	30%
Nugget Ice	88%	12%
Cubelet Ice	90%	10%

Due to the auger system the water consumption is equal to the ice production.





Updates to the FM and CM Range of Ice Makers

The new range of self – contained Flake (FM), Nugget and Cubelet (CM) machines offer improved features and enhancements.

Notable Improvements include:

- Automatic Flush Function – regular flushing to keep the ice making system clean
- One piece bin moulding – round corners are more hygienic and are easier to keep clean
- Integrated door handle design – for ease of opening and cleaning
- FM-150KE offers increased ice production capacity from model FM-120EE
- Controller board with Operation Status Display now easier to access - ensuring product durability and lower maintenance costs

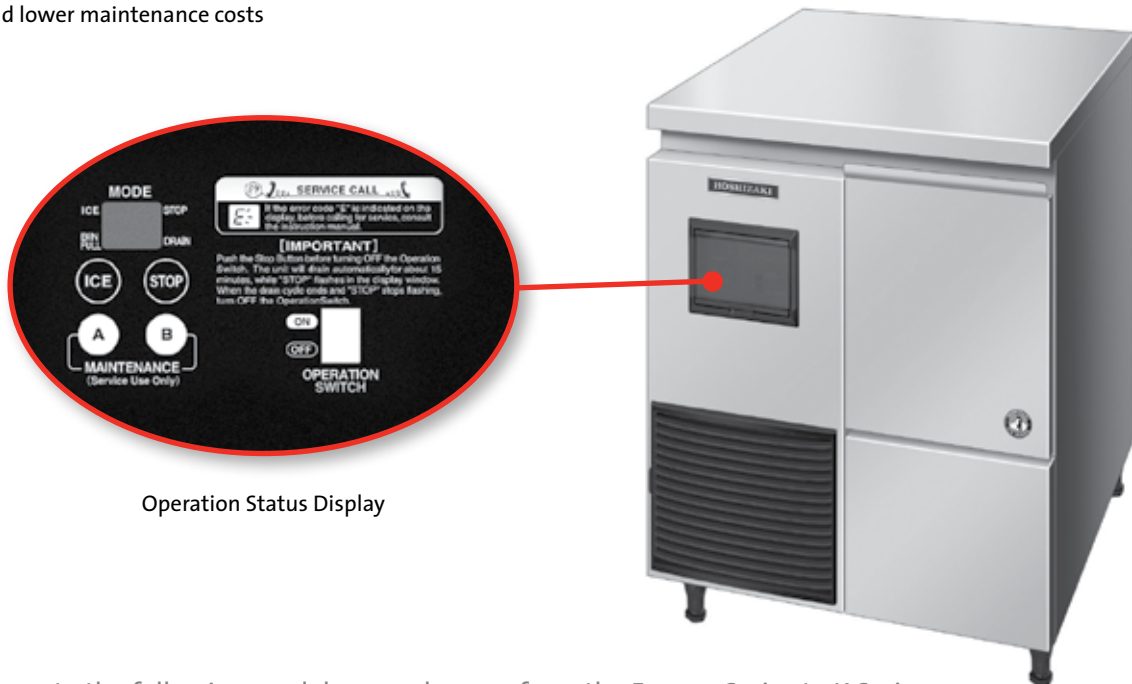

Operation Status Display

Please note the following model name changes from the Former Series to K Series:

Ice Type	Former Series	Improved K Series
Flake	FM-170AFE	FM-170AKE
	FM-481AWGE	FM-480AWKE
	FM-600AWHE	FM-600AWKE
	FM-481AGE-HC	FM-480AKE-HC
Nugget	FM-170AFE-N	FM-170AKE-N
	FM-481AWGE-N	FM-480AWKE-N
	FM-600AWHE-N	FM-600AWKE-N
	FM-481AGE-HC-N	FM-480AKE-HC-N



FM-80KE/-N

Production Capacity (kg/24h) Approx.	85(F) / 65(N)
Storage Bin Capacity (kg) Approx.	26(F) / 32(N)
Dimensions W x D x H (mm)	640 x 600 x 800
Electrical Supply	1/220 - 240V/50Hz
Electrical Capacity (kW)	0,3
Refrigerant	R134a
Weight Gross / Net (kg)	75/65
Air Cooled Model(s)	FM-80KE, FM-80KE-N
Type of Ice	FM-80KE – Flake Ice FM-80KE-N – Nugget Ice



FM-150KE/-N, CM-140KE

Production Capacity (kg/24h) Approx.	150(F) / 140(N) / 140(C)
Storage Bin Capacity (kg) Approx.	26(F) / 32(N) / 32(C)
Dimensions W x D x H (mm)	640 x 600 x 800
Electrical Supply	1/220 - 240V/50Hz
Electrical Capacity (kW)	0,64
Refrigerant	R134a
Weight Gross / Net (kg)	82/71
Air Cooled Model(s)	FM-150KE, FM-150KE-N, CM-140KE
Type of Ice	FM-150KE – Flake Ice FM-150KE-N – Nugget Ice CM-140KE – Cubelet Ice



FM-150KE-50/-N

Production Capacity (kg/24h) Approx.	150(F) / 140(N)
Storage Bin Capacity (kg) Approx.	57(F) / 65(N)
Dimensions W x D x H (mm)	940 x 600 x 800
Electrical Supply	1/220 - 240V/50Hz
Electrical Capacity (kW)	0,64
Refrigerant	R134a
Weight Gross / Net (kg)	94/81
Air Cooled Model(s)	FM-150KE-50, FM-150KE-50-N
Type of Ice	FM-150KE-50 – Flake Ice FM-150KE-50-N – Nugget Ice



- Production capacity (kg/24h): AT10°C, WT10°C

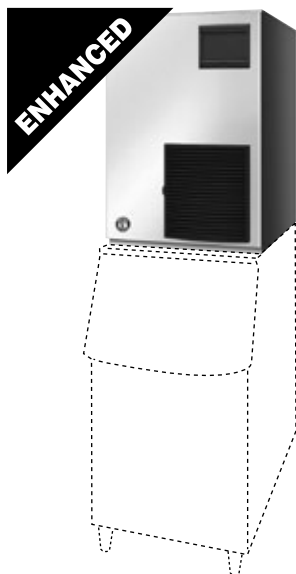

FM-170AKE/-N-SB

Production Capacity (kg/24h) Approx.	170(F) / 160(N)
Dimensions W x D x H (mm)	560 x 700 x 780
Electrical Supply	1/220 - 240V/50Hz
Electrical Capacity (kW)	0,60(F) / 0,62(N)
Refrigerant	R134a
Weight Gross / Net (kg)	75/68
Corresponding Bins	B-301SA, B-501SA, B-801SA
Top Kits	See page 51 for Configurations
Air Cooled Model(s)	FM-170AKE-SB, FM-170AKE-N-SB
Type of Ice	FM-170AKE-SB – Flake Ice FM-170AKE-N-SB – Nugget Ice

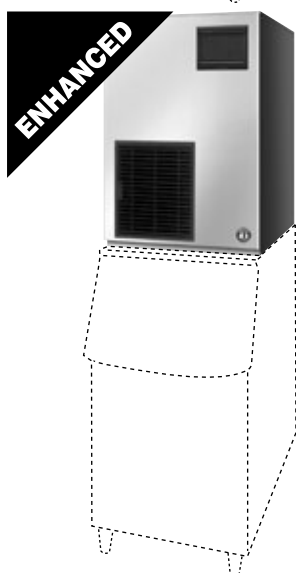

FM-300AKE/-N-SB

Production Capacity (kg/24h) Approx.	320(F) / 270(N)
Dimensions W x D x H (mm)	560 x 700 x 780
Electrical Supply	1/220 - 240V/50Hz
Electrical Capacity (kW)	1,0
Refrigerant	R404A
Weight Gross / Net (kg)	87/80
Corresponding Bins	B-301SA, B-501SA, B-801SA
Top Kits	See page 51 for Configurations
Air Cooled Model(s)	FM-300AKE-SB, FM-300AKE-N-SB
Type of Ice	FM-300AKE-SB – Flake Ice FM-300AKE-N-SB – Nugget Ice

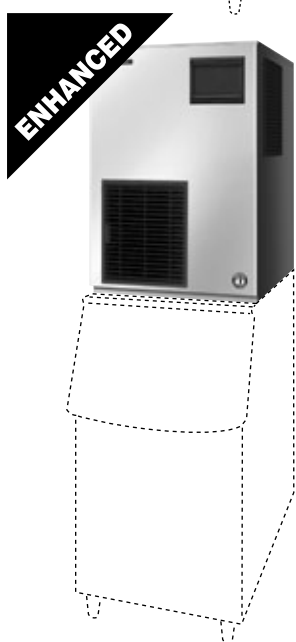

FM-480AKE/-N-SB

Production Capacity (kg/24h) Approx.	500(F) / 430(N)
Dimensions W x D x H (mm)	560 x 700 x 780
Electrical Supply	1/230V/50Hz
Electrical Capacity (kW)	1,65
Refrigerant	R404A
Weight Gross / Net (kg)	102/95
Corresponding Bins	B-301SA, B-501SA, B-801SA
Top Kits	See page 51 for Configurations
Air Cooled Model(s)	FM-480AKE-SB, FM-480AKE-N-SB
Water Cooled Model(s)	FM-480AWKE-SB, FM-480AWKE-N-SB
Air cooled Remote Model(s)	FM-481ALGE-SB*, FM-481ALGE-N-SB*
Type of Ice	FM-480AKE-SB, FM-480AWKE-SB, FM-481ALGE-SB* – Flake Ice FM-480AKE-N-SB, FM-480AWKE-N-SB, FM-481ALGE-N-SB* – Nugget Ice

*These products can be produced upon customer request. Please take longer lead times into consideration.

• Data shows the standard air cooled flake model • Production capacity (kg/24h): AT10°C, WT10°C



FM-600AKE/-N-SB

Production Capacity (kg/24h) Approx.	600(F) / 530(N)
Dimensions W x D x H (mm)	560 x 700 x 780
Electrical Supply	1/220 - 240V/50Hz
Electrical Capacity (kW)	1,90(F) / 1,95(N)
Refrigerant	R404A
Weight Gross / Net (kg)	114/107
Corresponding Bins	B-301SA, B-501SA, B-801SA
Top Kits	See page 51 for Configurations
Air Cooled Model(s)	FM-600AKE-SB, FM-600AKE-N-SB
Water Cooled Model(s)	FM-600AWKE-SB*, FM-600AWKE-N-SB*
Type of Ice	FM-600AKE-SB, FM-600AWKE-SB* – Flake Ice FM-600AKE-N-SB, FM-600AWKE-N-SB* – Nugget Ice

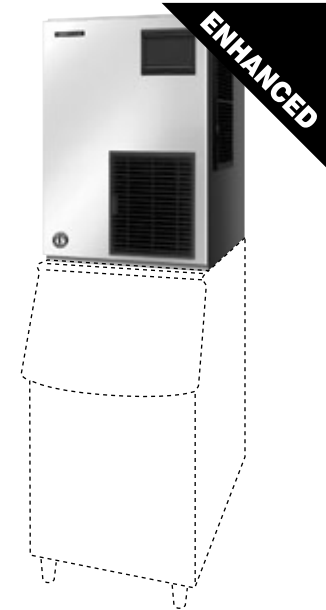

FM-750AKE/-N

Production Capacity (kg/24h) Approx.	750(F) / 590(N)
Dimensions W x D x H (mm)	762 x 700 x 780
Electrical Supply	1/220 - 240V/50Hz
Electrical Capacity (kW)	1,88(F) / 2,01(N)
Refrigerant	R404A
Weight Gross / Net (kg)	143/133
Corresponding Bins	B-501SA, B-801SA
Top Kits	See page 51 for Configurations
Air Cooled Model(s)	FM-750AKE, FM-750AKE-N
Type of Ice	FM-750AKE – Flake Ice FM-750AKE-N – Nugget Ice

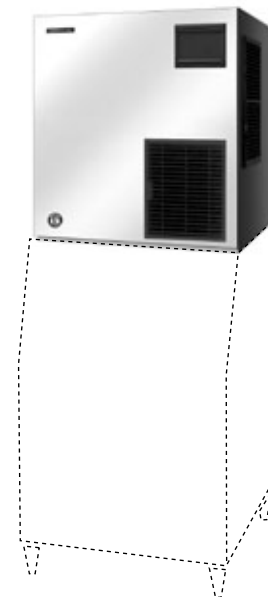

FM-1000AKE/-N

Production Capacity (kg/24h) Approx.	1030(F) / 860(N)
Dimensions W x D x H (mm)	762 x 700 x 780
Electrical Supply	1/220 - 240V/50Hz
Electrical Capacity (kW)	2,49(F) / 2,55(N)
Refrigerant	R404A
Weight Gross / Net (kg)	156/146
Corresponding Bins	B-501SA, B-801SA
Top Kits	See page 51 for Configurations
Air Cooled Model(s)	FM-1000AKE, FM-1000AKE-N
Type of Ice	FM-1000AKE – Flake Ice FM-1000AKE-N – Nugget Ice

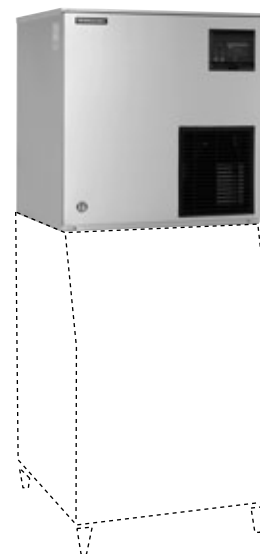

*These products can be produced upon customer request. Please take longer lead times into consideration.

• Data shows the standard air cooled flake model • Production capacity (kg/24h): AT10°C, WT10°C

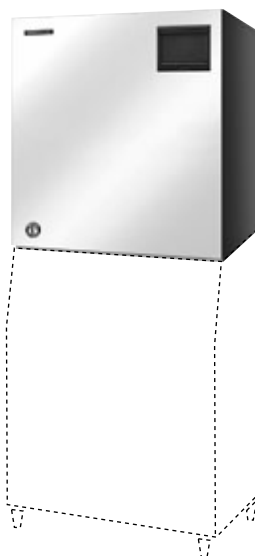

FM-1200ALKE/-N

Production Capacity (kg/24h) Approx.	1200(F) / 1060(N)
Dimensions W x D x H (mm)	762 x 700 x 780
Electrical Supply	1/220 - 240V/50Hz
Electrical Capacity (kW)	0,47(F) / 0,515(N)
Refrigerant	R404A
Weight Gross / Net (kg)	108/98
Excluding the Remote Refrigeration Unit	2,83kW – -25°C
Corresponding Bins	B-501SA, B-801SA
Top Kits	See page 51 for Configurations
Air Cooled Model(s) Without Refrigeration Unit	FM-1200ALKE, FM-1200ALKE-N
Type of Ice	FM-1200ALKE – Flake Ice FM-1200ALKE-N – Nugget Ice

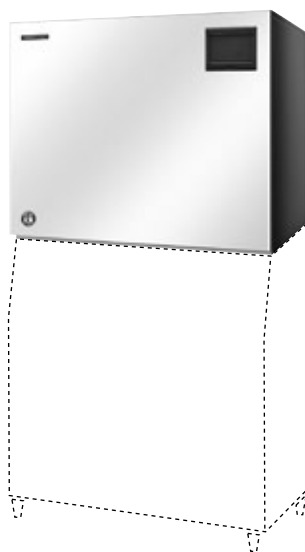

FM-1800ALKE/-N

Production Capacity (kg/24h) Approx.	1800(F) / 1370(N)
Dimensions W x D x H (mm)	1080 x 700 x 780
Electrical Supply	1/220 - 240V/50Hz
Electrical Capacity (kW)	0,71(F) / 0,77(N)
Refrigerant	R404A
Weight Gross / Net (kg)	155/140
Excluding the Remote Refrigeration Unit	4,3kW – -25°C
Corresponding Bins	B-801SA
Top Kits	See page 51 for Configurations
Air Cooled Model(s) Without Refrigeration Unit	FM-1800ALKE, FM-1800ALKE-N
Type of Ice	FM-1800ALKE – Flake Ice FM-1800ALKE-N – Nugget Ice



FM Hydrocarbon Machines

Hydrocarbons have proven to be more energy- efficient than most conventional refrigerant systems. We use an extremely low level of the refrigerant R290 (propane) within our fully compliant hydrocarbon FM series ice makers, using well below the legal allowance of hydrocarbon. Our FM-481AGE-HC hydrocarbon ice maker uses a total charge of only 156gr of R290 within a dual system whereas the equivalent R404a version utilizes a charge of 770gr. When using hydrocarbon R290 ice makers, energy consumption is lowered by up to 20% in one unit which also reduces carbon emissions from energy suppliers (power stations) and saves on operators running costs.



**ECOFRIENDLY
HFCFREE**

Hoshizaki's HFC Free units within the FM series use 100% HFC free CO² foam insulation which helps to further reduce running costs by maintaining a uniform unit temperature and also contributes to reducing direct Green House Gas emissions.

The molecular make up of hydrocarbons means that they are able to work at lower pressures to reduce the stress on the system units. This has the added potential benefit of reducing compressor running times, all contributing to a lower operating temperature, less heat and noise, more durable components and extended machine lifespan.

This combined with the high quality and durable designs of Hoshizaki units means that operators will see a long term return on their equipment investment.



FM Ice Machines - Hydrocarbon

www.hoshizaki-europe.com



• Photo of FM-170EE-HC/HCN

FM-170EE-HC/HCN* / FM-170EE-50-HC/HCN*

Production Capacity (kg/24h) Approx.	165 (F) / 145 (N)
Storage Bin Capacity (kg) Approx.	26(F) / 32(N) / 57(-50)
Dimensions W x D x H (mm)	640 x 600 x 800 / 940 x 600 x 800 (-50)
Electrical Supply	1/220 - 240V/50Hz
Electrical Capacity (kW)	0,495(F) / 0,500(N)
Refrigerant	R290
Weight Gross / Net (kg)	82/71, 94/81(-50)
Air Cooled Model(s)	FM-170EE-HC*, FM-170EE-HCN*, FM-170EE-50-HC*, FM-170EE-HCN*
Type of Ice	FM-170EE-HC*, FM-170EE-50-HC* – Flake Ice FM-170EE-HCN*, FM-170EE-50-HCN* – Nugget Ice

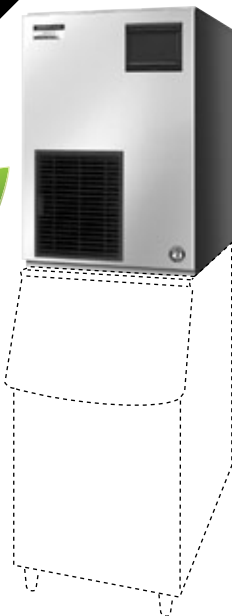

FM-300AKE-HC/HCN-SB*

Production Capacity (kg/24h) Approx.	300 (F) / 250 (N)
Dimensions W x D x H (mm)	560 x 700 x 780
Electrical Supply	1/220 - 240V/50Hz
Electrical Capacity (kW)	0,9(F) / 0,96(N)
Refrigerant	R290
Weight Gross / Net (kg)	88/81
Corresponding Bins	B-301SA, B-501SA, B-801SA
Air Cooled Model(s)	FM-300AKE-HC-SB*, FM-300AKE-HCN-SB*
Type of Ice	FM-300AKE-HC-SB* – Flake Ice FM-300AKE-HCN-SB* – Nugget Ice

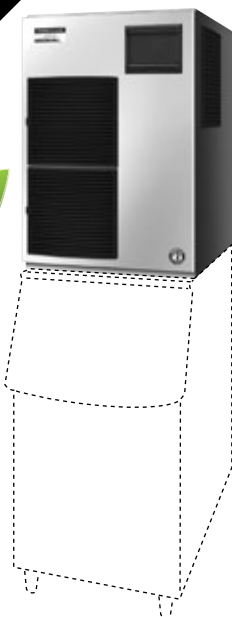

FM-480AKE-HC/HCN-SB

Production Capacity (kg/24h) Approx.	450 (F) / 380 (N)
Dimensions W x D x H (mm)	560 x 700 x 780
Electrical Supply	1/220 - 240V/50Hz
Electrical Capacity (kW)	1,10(F) / 1,17(N)
Refrigerant	R290
Weight Gross / Net (kg)	99/92
Corresponding Bins	B-301SA, B-501SA, B-801SA
Air Cooled Model(s)	FM-480AKE-HC-SB, FM-480AKE-HCN-SB
Type of Ice	FM-480AKE-HC-SB – Flake Ice FM-480AKE-HCN-SB – Nugget Ice

*These products can be produced upon customer request. Please take longer lead times into consideration.

• Production capacity (kg/24h): AT10°C, WT10°C



Ice and/or Water Dispensers

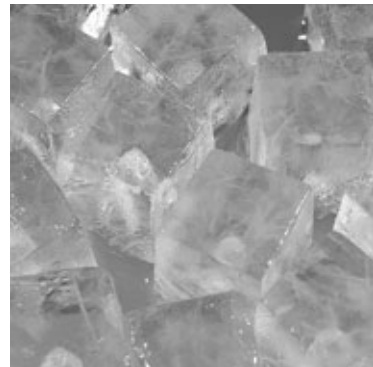





Ice and/or Water Dispensers

Product Highlights



- Ice and/or water mix at the touch of a button, making it as easy and simple to use as possible and therefore ideal for self-service environments.



- Portion control can be easily set, making it easy to regulate the consumption of ice among end-users, reducing energy consumption and waste.
- Due to the auger system the water consumption is equal to the ice production.

The New DCM-6oKE





Ice and/or Water Dispensers

www.hoshizaki-europe.com



DSM-12CE

Production Capacity (kg/24h) Approx.	13
Storage Bin Capacity (kg) Approx.	3
Dimensions W x D x H (mm)	180 x 510 x 695
Electrical Supply	1/220 - 240V/50Hz
Electrical Capacity (kW)	0,26
Refrigerant	R134a
Weight Gross / Net (kg)	26/23
Type of Ice	Shuttle ice



DCM-60KE (-P)

Production Capacity (kg/24h) Approx.	60
Storage Bin Capacity (kg) Approx.	1,9
Dimensions W x D x H (mm)	350 x 585 x 695 (max 710)
Electrical Supply	1/220 - 240V/50Hz
Electrical Capacity (kW)	0,28
Refrigerant	R134a
Weight Gross / Net (kg)	56/47
Type of Ice	Cubelet + Water
Available With	Lever/Push button (-P)
Optional	Push button on request (-P)



DCM-120KE (-P)

Production Capacity (kg/24h) Approx.	125
Storage Bin Capacity (kg) Approx.	4
Dimensions W x D x H (mm)	350 x 585 x 815 (max 830)
Electrical Supply	1/220 - 240V/50Hz
Electrical Capacity (kW)	0,48
Refrigerant	R134a
Weight Gross / Net (kg)	66/57
Type of Ice	Cubelet + Water
Available With	Lever/Push button (-P)
Optional	Push button on request (-P)

• Production capacity (kg/24h): AT10°C, WT10°C



DCM-230HE

Production Capacity (kg/24h) Approx.	230
Storage Bin Capacity (kg) Approx.	18
Dimensions W x D x H (mm)	660 x 571 x 1016
Electrical Supply	1/230V/50Hz
Electrical Capacity (kW)	0,815
Refrigerant	R404A
Weight Gross / Net (kg)	120/108
Type of Ice	Cubelet + Water



DIM-30DE-1

Production Capacity (kg/24h) Approx.	32
Storage Bin Capacity (kg) Approx.	15
Dimensions W x D x H (mm)	350 x 526 x 1590
Electrical Supply	1/220- 240V/50Hz
Electrical Capacity (kW)	0,32
Refrigerant	R134a
Weight Gross / Net (kg)	71/65
Type of Ice	Cube



- Production capacity (kg/24h): AT10°C, WT10°C

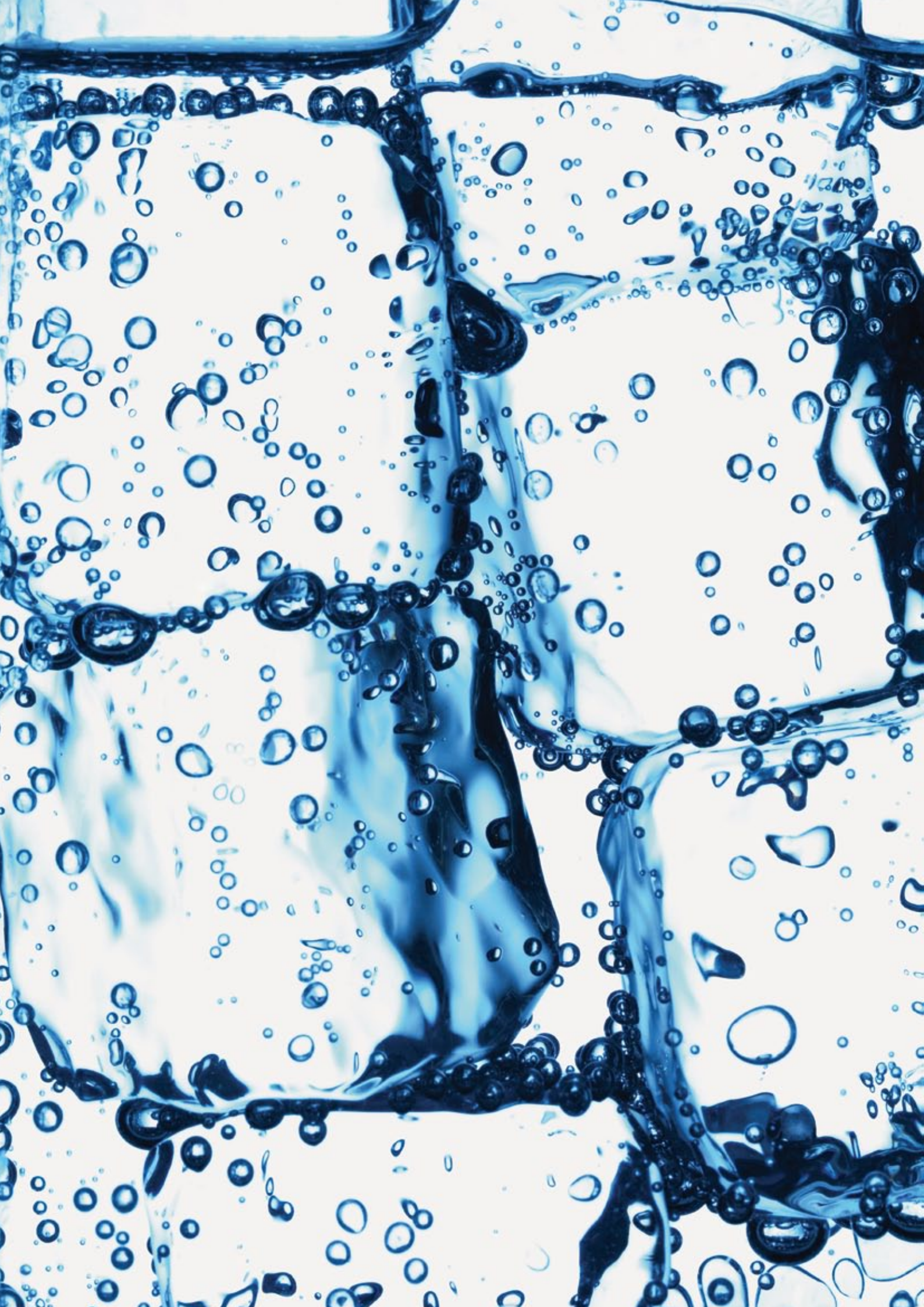



Bins, Transport Systems and Crushers

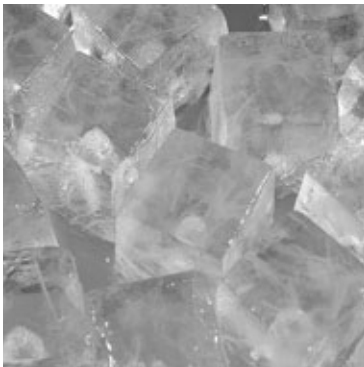





Storage Bins

In order to ensure ample quantities of ice at all times, Hoshizaki offers a wide range of Storage Bins that configure perfectly with Hoshizaki Ice Machines.

The stainless steel exterior provides for easy cleaning and a long lasting attractive appearance.

Sturdy construction for side by side or stacked installations and non-corrosive bin liner provide safe, sanitary storage of cube or flake ice. Foamed in place insulation in all bin walls provides dependable, low melt rate ice storage.

The size of the bins depends on several factors – the capacity of the machine, the average daily demand and the peak demand.



Storage bins, manufactured by Hoshizaki are made of stainless steel and come with legs adjustable between 90 - 120 mm.



Bins are easy to clean with round edges for optimal hygiene.



Hoshizaki Ice Storage Bins

www.hoshizaki-europe.com



B-301SA

Bin Capacity (kg) Approx.	144
Dimensions W x D x H (mm)	560 x 820 x 1016 (Excluding legs)
Weight Gross / Net (kg)	49/37



B-501SA

Bin Capacity (kg) Approx.	217
Dimensions W x D x H (mm)	762 x 820 x 1016 (Excluding legs)
Weight Gross / Net (kg)	57/47



B-801SA

Bin Capacity (kg) Approx.	348
Dimensions W x D x H (mm)	1220 x 820 x 1016 (Excluding legs)
Weight Gross / Net (kg)	86/64
Optional	Bin dividers on request

OTHER BRANDED BINS

Model	Bin Capacity (kg) Approx.	Dimensions (Including legs) W x D x H (mm)	Weight (kg)
F-600-42S	246	1087 x 686 x 1019	70
F-650-44S	299	1118 x 800 x 1016	84
F-950-48S	431	1219 x 800 x 1270	110
F-1025-52S	467	1320 x 800 x 1270	111



Top Kits

Some ice machine bin combinations may require a top kit. Please check the following table for possible configurations with the appropriate top kit.

If you wish to combine one of our ice makers with an other branded bin, please consult us as other top kits may apply.

TOP KITS

TK 4 DM	TK 18 D
TK 4 DR	TK IMD2
TK 8 D	TK 1800

TOP KIT CONFIGURATIONS

Quantity	Ice Machine Model	B-301SA	B-501SA	B-801SA
	IM-240D	n.a.	n.a.	TK IMD2
	IM-240A	–	TK 8 D	TK 8 D + TK 18 D
	KM-320/515/650	n.a.	TK 8 D	TK 8 D + TK 18 D
2x	KM-320/515/650	n.a.	n.a.	TK 4 DM
	KM-1301	n.a.	n.a.	–
	KMD-201	–	TK 8 D	TK 8 D + TK 18 D
	KMD-270	–	TK 8 D	TK 8 D + TK 18 D
	FM-170	–	TK 8 D	TK 8 D + TK 18 D
	FM-300/-HC	–	TK 8 D	TK 8 D + TK 18 D
	FM-480/-HC	–	TK 8 D	TK 8 D + TK 18 D
	FM-600	–	TK 8 D	TK 8 D + TK 18 D
	FM-750	n.a.	–	TK 18 D
	FM-1000	n.a.	–	TK 18 D
	FM-1200	n.a.	–	TK 18 D
	FM-1800	n.a.	n.a.	TK 1800
2x	IM-240A	n.a.	n.a.	TK 4 DM
2x	KM-650	n.a.	n.a.	TK 4 DM
2x	KMD-201	n.a.	n.a.	TK 4 DM + TK 4 DR
2x	KMD-270	n.a.	n.a.	TK 4 DM + TK 4 DR
2x	FM-170	n.a.	n.a.	TK 4 DM
2x	FM-300	n.a.	n.a.	TK 4 DM
2x	FM-480	n.a.	n.a.	TK 4 DM
2x	FM-600	n.a.	n.a.	TK 4 DM

– = no top kit necessary
 n.a. = combination of ice maker and bin is not possible.



Transport Systems

Transportation methods from Hoshizaki include a range of trolleys, carts and bagging methods that are integrated as storage compartments within the ice machines themselves. Once full, simply remove the trolley or bag full of ice, and carry or wheel it to wherever it is needed, without needing to scoop it from the machine into a receptacle.

As well as reducing the risk of contamination, these methods save valuable time that would otherwise be lost shovelling ice one scoop at a time.

It is very important that the opportunity for contamination (i.e. from human contact) is minimized, and Hoshizaki's systems do this, allowing the transportation of ice in large quantities without human manpower.



ICE TRANSPORT SYSTEMS

Model	No. of carts	Bin Capacity (kg) Approx.	Dimensions W x D x H (mm)	Weight (kg)
ITS-100-31	1	45 (+109)	788 x 1016 x 1178	110
ITS-500-31	1	227 (+109)	788 x 1016 x 1524	166
ITS-600-31	1	272 (+109)	788 x 1016 x 1703	176
ITS-700-31	1	318 (+109)	788 x 1016 x 1905	187
ITS-1350-60	2	612 (+218)	1524 x 1016 x 1905	390
ITS-2250-60	2	955 (+218)	1524 x 1016 x 2464	420



SBF

Frame Dimensions W x D x H (mm)	720 x 960 x 990
Cart W x D x H (mm)	560 x 1090 x 890
Cart Positioned in Frame W x D x H (mm)	720 x 1150 x 990

The cart requires 1100mm space to allow removal from the frame.
Optional: Additional ice cart



ICE BAGGING & DISPENSING SYSTEMS

Model	Bin Capacity Approx. (kg)	Dimensions W x D x H (mm)	Weight (kg)
DB-650SA	295	858 x 1226 x 1651	205
DB-1000SA	454	1321 x 1156 x 1823	320

ICE STORAGE & DISPENSING SYSTEMS

Model	Bin Capacity Approx. (kg)	Dimensions (Including legs) W x D x H (mm)	Weight (kg)
DEV-500SG-30-75	209	762 x 788 x 1570	136
DEV-700SG-30-75	308	762 x 788 x 1969	146



UPRIGHT STORAGE BINS

Model	Bin Capacity Approx. (kg)	Dimensions (Including legs) W x D x H (mm)	Weight (kg)
SG-500-30	209	762 x 788 x 1105	96
SG-700-30	308	762 x 788 x 1486	100

Optional:

- Additional ice cart
- Set of 6 totes

Also available upon request:

- Full range of stands for ice machines and storage bins.
- Ice machines with full stainless steel frames and mobile cart.
- Other storage, transport, bagging and dispensing systems.



Ice Crushers

- Hoshizaki Ice Crushers are easy to operate and very compact.
- Ideal for crushing large quantities of ice cubes for perfectly presented drinks.
- Crushers are small enough to place on bars or countertops and will crush 3-5 kg of ice in just 60 seconds.



C-103

Crush Capacity (kg/min) Approx.	3
Storage Capacity (kg) Approx.	1
Dimensions W x D x H (mm)	180 x 330 x 320
Electrical Supply	1/220 - 240V/50Hz
Electrical Capacity (kW)	0,15
Weight Gross / Net (kg)	10



C-105

Crush Capacity (kg/min) Approx.	5
Storage Capacity (kg) Approx.	5
Dimensions W x D x H (mm)	370 x 310 x 510
Electrical Supply	1/220 - 240V/50Hz
Electrical Capacity (kW)	0,15
Weight Gross / Net (kg)	25



Sushi Cases

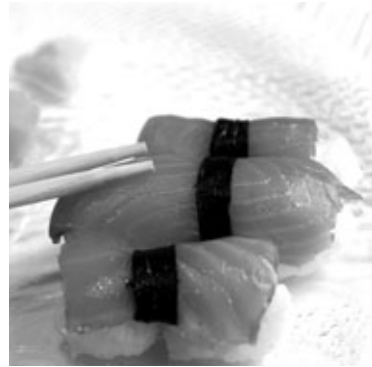



Product Highlights

Hoshizaki's HNC Sushi Cases are designed to be aesthetically appealing. They are produced to sit on counter tops, with a contemporary and modern design that looks great as well keeping your sushi cooled at exactly the right temperature.



- Stable humidity and temperature levels are maintained at all times, instead of forced air circulation methods that dry out and ruin displayed sushi. Your sushi will stay fresh longer and taste as good as it looks.
- Hoshizaki machines will not defrost and allow condensation to drip onto the sushi displayed within them, protecting the integrity of the product at all times.



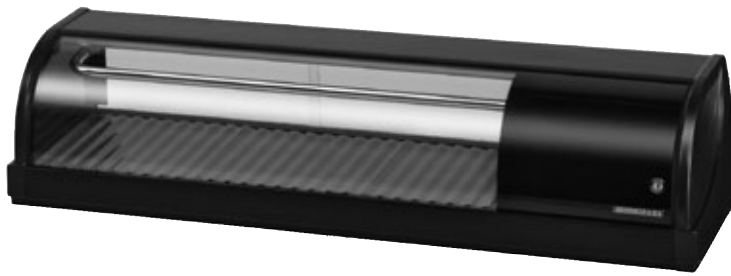

Right Version Shown

HNC-120BE

Net Capacity (L)	42
Temperature (°C) Approx.	5
Dimensions W x D x H (mm)	1200 x 345 x 270
Electrical Supply	1/220 - 240V/50Hz
Electrical Capacity (kW)	0,15
Refrigerant	R134a
Weight Gross / Net (kg)	44/32
Compressor (Left side)	HNC-120BE-L
Compressor (Right side)	HNC-120BE-R



Left Version Shown

HNC-150BE

Net Capacity (L)	57
Temperature (°C) Approx.	5
Dimensions W x D x H (mm)	1500 x 345 x 270
Electrical Supply	1/220 - 240V/50Hz
Electrical Capacity (kW)	0,15
Refrigerant	R134a
Weight Gross / Net (kg)	52/37
Compressor (Left side)	HNC-150BE-L
Compressor (Right side)	HNC-150BE-R

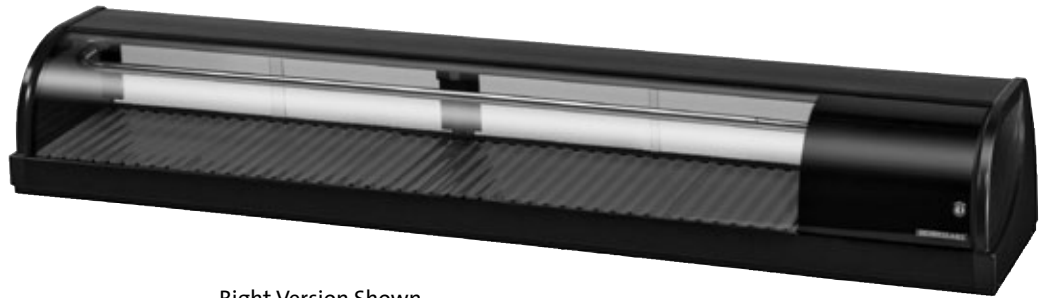

Right Version Shown

HNC-180BE

Net Capacity (L)	72
Temperature (°C) Approx.	5
Dimensions W x D x H (mm)	1800 x 345 x 270
Electrical Supply	1/220 - 240V/50Hz
Electrical Capacity (kW)	0,15
Refrigerant	R134a
Weight Gross / Net (kg)	60/42
Compressor (Left side)	HNC-180BE-L
Compressor (Right side)	HNC-180BE-R



Left Version Shown

HNC-210BE

Net Capacity (L)	87
Temperature (°C) Approx.	5
Dimensions W x D x H (mm)	2100 x 345 x 270
Electrical Supply	1/220 - 240V/50Hz
Electrical Capacity (kW)	0,15
Refrigerant	R134a
Weight Gross / Net (kg)	68/47
Compressor (Left side)	HNC-210BE-L
Compressor (Right side)	HNC-210BE-R



HOSHIZAKI

Hoshizaki Europe B.V.

Tel. +31 20 6918499
Fax +31 20 6918768
sales@hoshizaki.nl

Hoshizaki UK (UK, Ireland)

Tel. +44 845 456 0585
Fax +44 132 283 8331
uksales@hoshizaki.co.uk

Hoshizaki Deutschland (Germany, Switzerland, Austria)

Tel. +49 2154/92810
Fax +49 2154/928128
info@hoshizaki.de

Hoshizaki France

Tel. +33 1 48 63 93 80
Fax +33 1 48 63 93 88
info@hoshizaki.fr

Hoshizaki Iberia (Spain, Portugal)

Tel. +34 93 478 09 52
Fax +34 93 478 08 00
info@hoshizaki.es

Hoshizaki Middle East

Tel. +971 48 876 612
Fax +971 48 876 613
sales@hoshizaki.ae

Hoshizaki Nederland & België

Tel. +31 20 5650420 (Nederland)
Tel. +32 2 712 30 30 (België)
Fax +31 20 6918768
sales@hoshizaki.nl (Nederland)
info@hoshizaki.be (België)

www.hoshizaki-europe.com

Every effort has been made to ensure that the information contained in this publication is accurate at the time of publishing. Hoshizaki Europe B.V. assumes no responsibility or liability for typographical errors or omissions or for any misinterpretation of the information within the publication and reserves the right to change without notice.